



Horizon Oil Limited ABN 51 009 799 455
Level 6, 134 William Street, Woolloomooloo NSW Australia 2011
Tel +61 2 9332 5000, Fax +61 2 9332 5050 www.horizonoil.com.au

7 September 2017

The Manager, Company Announcements
ASX Limited
Exchange Centre
20 Bridge Street
Sydney NSW 2000

**HORIZON OIL (HZN)
PNG INVESTMENT CONFERENCE PRESENTATION**

Attached is Horizon Oil's presentation to the PNG Investment Conference held at Shangri-la Hotel, Sydney today.

Yours faithfully,

Kylie Quinlivan
Corporate Counsel & Assistant Company Secretary

For more information please contact:

Horizon Oil Limited
Brent Emmett Chief Executive Officer

T: +61 2 9332 5000
F: +61 2 9332 5050
E: info@horizonoil.com.au

Level 6, 134 William St
Woolloomooloo NSW 2011
horizonoil.com.au

Media enquiries
Gavan Collery
ResourceComms Pty Ltd

M: +61 419 372 210
E: gavan@resourcecomms.com





HORIZON OIL LIMITED / ABN 51 009 799 455

Developing Gas in Papua New Guinea's Western Province

Brent Emmett CEO

**Papua New Guinea
Investment Conference**

7 & 8 September 2017

Disclaimer



Statements contained in this material, particularly those regarding the possible or assumed future performance, costs, dividends, returns, production levels or rates, prices, reserves, potential growth of Horizon Oil Limited, industry growth or other trend projections and any estimated company earnings are or may be forward looking statements. Such statements relate to future events and expectations and as such involve known and unknown risks and uncertainties. Actual results, actions and developments may differ materially from those expressed or implied by these forward looking statements depending on a variety of factors.

While every effort is made to provide accurate and complete information, Horizon Oil accepts no responsibility for any loss, damage, cost or expense incurred by you as a result of any error, omission or misrepresentation in information in this presentation.

In this presentation, estimates of petroleum resources may be reported in units of equivalency between gas to oil (reported as barrels of oil equivalent (boe)). A conversion factor of 6 cubic feet of gas to 1 barrel of oil has been applied.

The reserve and resource information contained in this presentation is based on information compiled by Alan Fernie (Manager – Exploration and Development). Mr Fernie (B.Sc), who is a member of AAPG, has more than 38 years relevant experience within the industry and consents to the information in the form and context in which it appears.

All dollars in the presentation are United States dollars unless otherwise noted.

Presentation key points



- Where Western LNG sits in the Papua New Guinea LNG landscape
- Western Province hosts a large gas and condensate resource, well-defined by seismic, appraisal drilling and testing
- Planning for an uncomplicated, low-risk 1.5 mtpa LNG development and export scheme is at an advanced stage
- Western LNG will bring significant benefits to Western Province landowners and communities and to the State

Papua New Guinea's LNG landscape

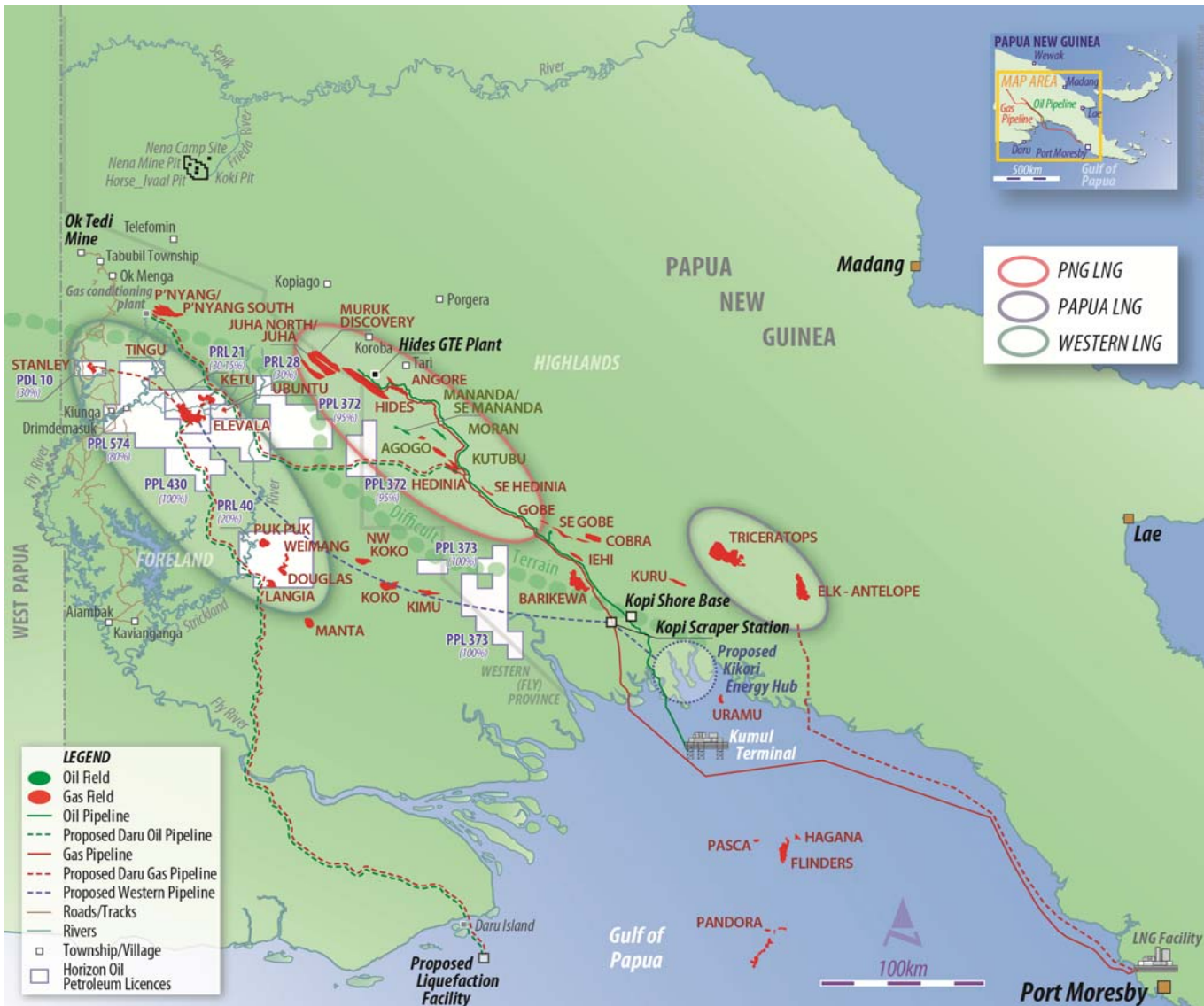

- PNG is a pro development jurisdiction with stable petroleum fiscal regime
- Rich mineral and petroleum province with a history of successful large scale resource projects delivery e.g. PNG LNG
- Jurisdiction well supported by the international banks
- Challenging logistics, however capital and operating cost environment is competitive in the region

Appraised western foreland fields to be aggregated for Western LNG

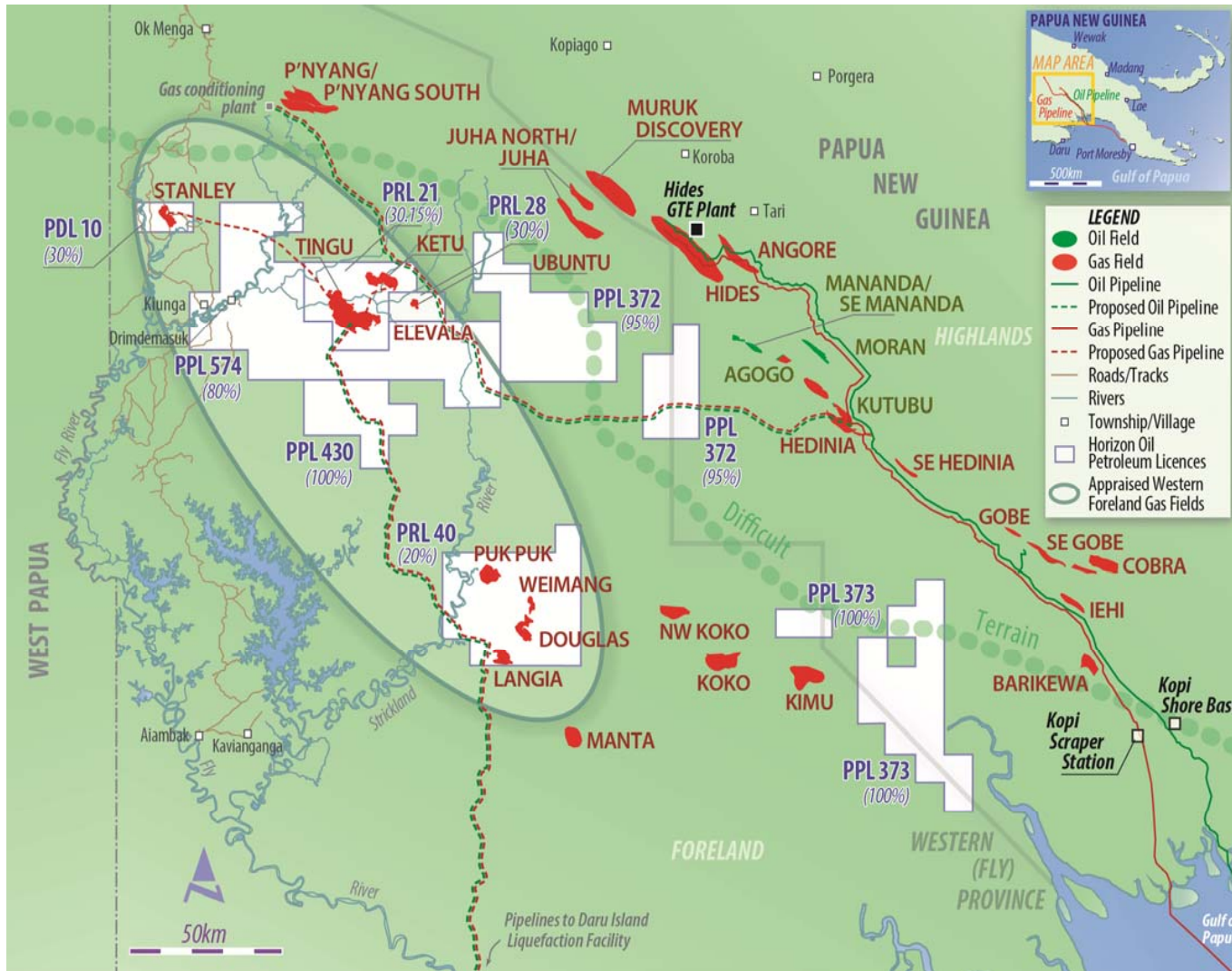

- Significant gas resource discovered and appraised in uncomplicated structures, with highly productive sandstone reservoirs
- High level of condensate and LPG contained in the gas
- Relatively easy surface access and terrain for field operations

Appraised western foreland fields – resource distribution and ownership



- **Horizon Oil and Repsol have a combined interest of 70% of the total resource and operate all the fields , which will facilitate aggregation**
- **Contingent resource (2C) : 2.0 – 2.5 tcf gas
60 – 70 mmbbl condensate**

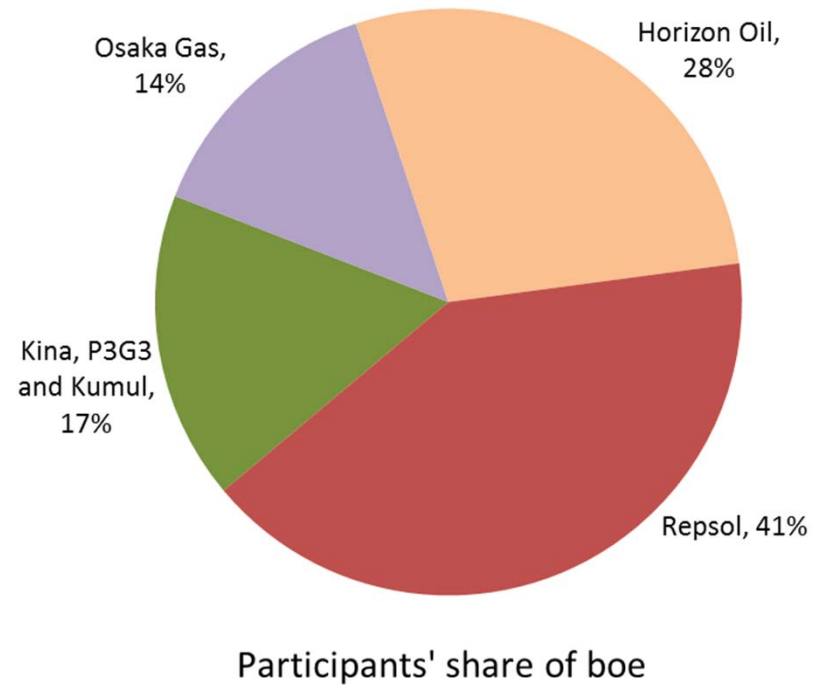
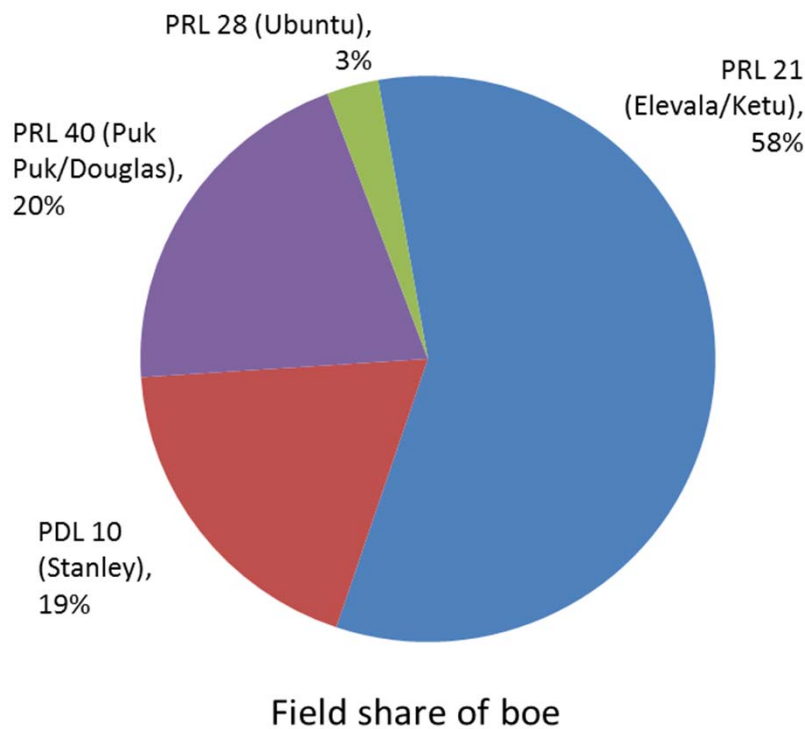

Note: Petroleum resource ranges used in this presentation are based on Horizon Oil's 2017 Reserves and Resources Statement, announced on 29 August 2017

Western LNG development scheme

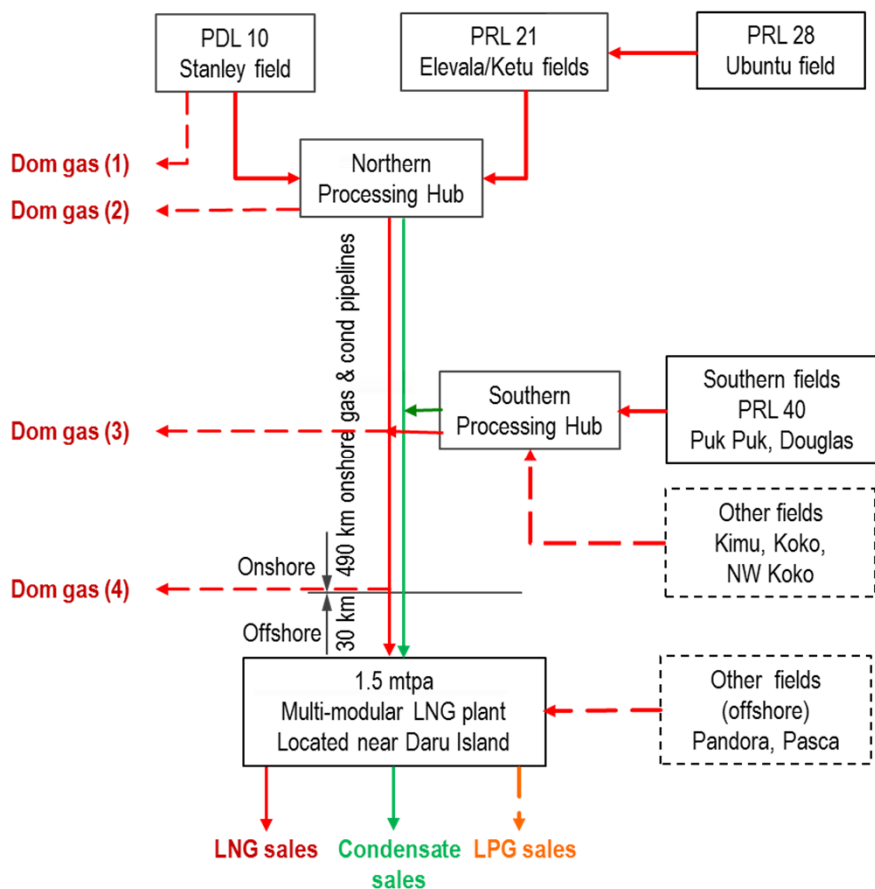

- Gas for the domestic PNG market available at multiple locations
- LNG, condensate and LPG available for PNG-based customers at liquefaction facility

W LNG development - 1.5 mtpa sales capacity
Aggregated raw gas production profile - 2C resources

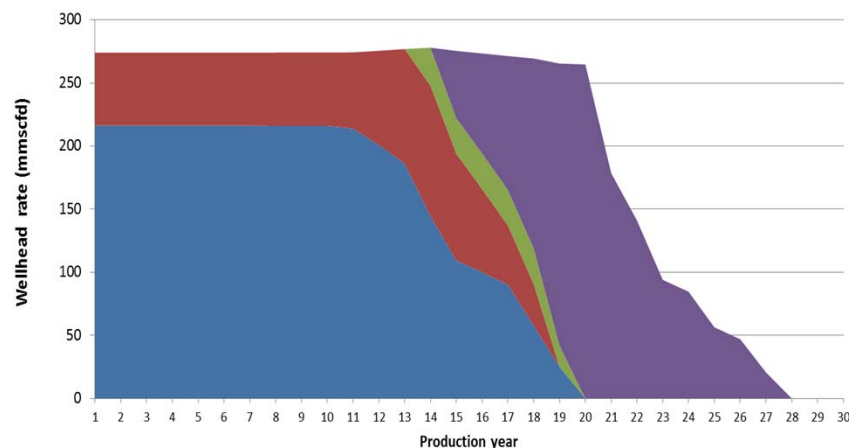

W LNG development - 1.5 mtpa sales capacity
Aggregated raw gas production profile - 1C resources

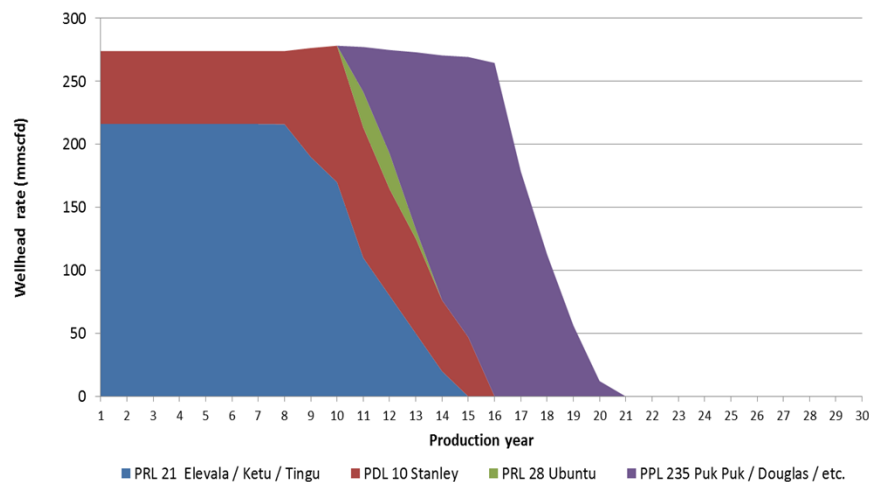

Development scheme selection criteria



Upstream gas processing plant



Gas and condensate export pipelines



Near shore liquefaction facility

- Standalone development – 1.5 mtpa right-sized for appraised resource base
- Simple concept with lowest technical and execution risk
- Maximum use of standard, proven technology
- System uptime consistent with global LNG projects (90-95%)
- Utilisation of leading contractors, preferably with prior PNG experience

WLNG well-placed to supply emerging demand areas – Indonesia, South China Sea Rim, China, India

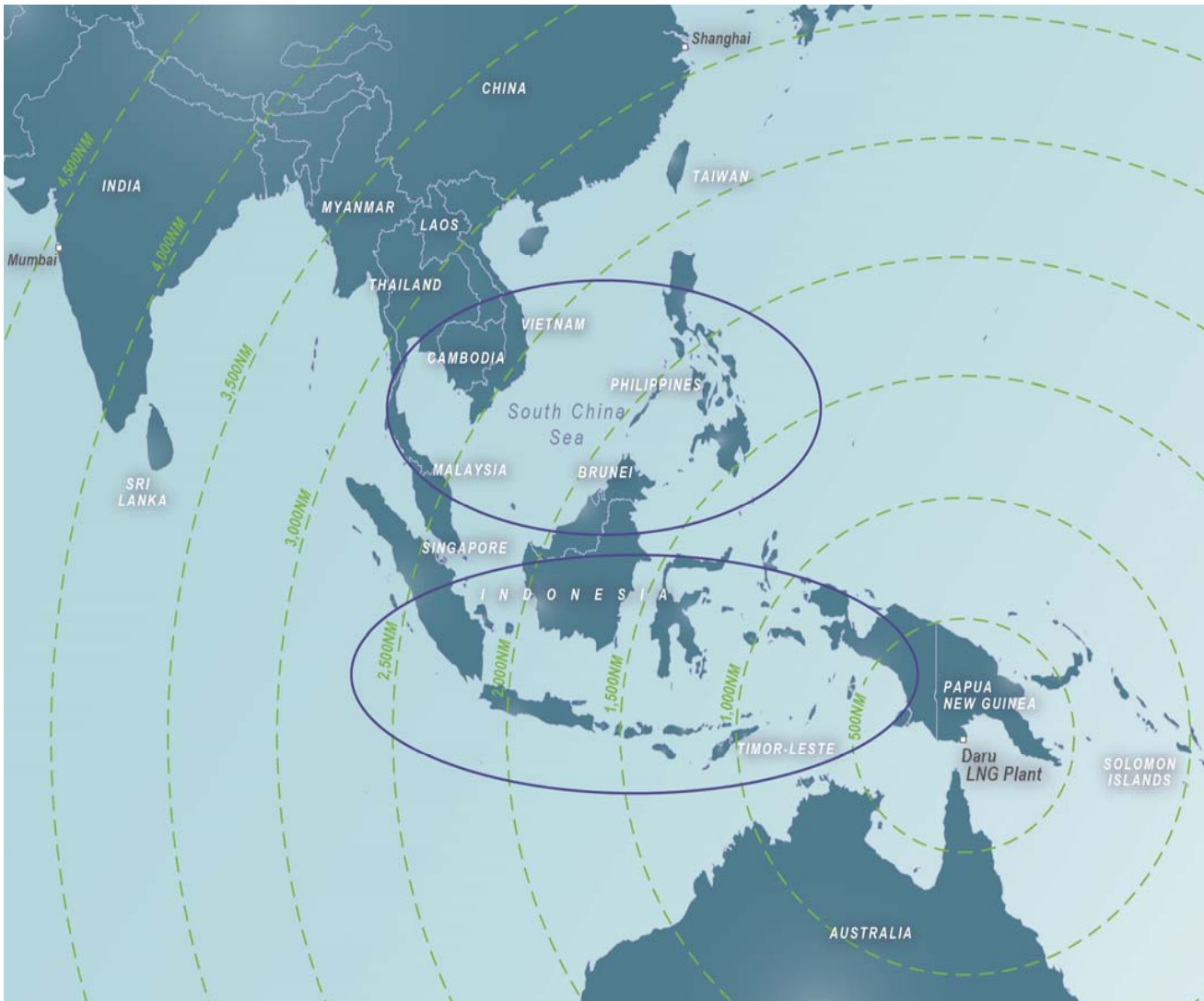

- Strong increase in demand forecast in emerging Asian economies, pointing to supply shortfalls from 2023
- Many new entrants seeking to import LNG to:
 - Offset decline in domestic gas supply
 - Displace liquid fuel for power generation
 - Diversify energy mix
- New buyers looking for flexible supply arrangements and smaller cargoes
- Advent of FSRUs will facilitate and expedite implementation of smaller projects

Benefits – to landowners, communities and the State



- Creates long term employment and economic development opportunities in Western Province
- Powerful generator of tax revenue and export income for 20+ year project life and will reduce reliance on hard currency-funded imports
- Provides gas for power generation for PNG mines, industries and communities, as well as gas to PNG-located industrial consumers (eg. methanol, fertilizer)
- Project infrastructure will benefit communities, the petroleum industry and other industries
- Potential to lift health and education standards

Horizon Oil's health and community initiatives



Water and sanitation



Remote area health patrols



Vocational training and life skills



Case based training for rural health workers



Our partners



Community health education



For more information please contact:

Horizon Oil Limited
Brent Emmett Chief Executive Officer

Media enquiries
Gavan Collery
ResourceComms Pty Ltd

T: +61 2 9332 5000
F: +61 2 9332 5050
E: info@horizonoil.com.au

M: +61 419 372 210
E: gavan@resourcecomms.com

Level 6, 134 William St
Woolloomooloo NSW 2011
horizonoil.com.au 

